

# Time Card Holders for Model 179

**Price: \$38.50**



**Manufacturer:**



## **Description**

Are you tired of your employees losing their [time cards](#)? Misplacing them?



Do you want to save time on the payroll time tracking process?

Our heavy duty metal time card racks will organize, keep track and accelerate the employee clocking in and out process. Durable time card racks at an affordable price is a simple solution to managing your business.

### **Employee Time Card Rack Model 179 specifications:**

- ✓ **Stock Number:** 179
- ✓ **Capacity:** 25
- ✓ **Suggested Card Height:** 7 1/2 inches
- ✓ **Overall Height:** 31 5/8 inches
- ✓ **Overall Width:** 5 inches
- ✓ **Opening Width:** 4 1/4 inches
- ✓ **Depth (Front to Back):** 1 3/4 inches
- ✓ **Pocket Depth:** 6 1/4 inches
- ✓ **Exposure:** 1 inch

You can also customize your order of Time Card Rack 179 by choosing a different color than the default gray.

Here are the color options:

**Black, Brown, Gray, Ivory, Light Tan, Orange, Red, Traffic Blue, White and Taupe.**



There is an additional charge of \$5.00 for the color selection. If you order a custom color, a representative will contact you to collect the additional cost.

If you have any questions regarding this employee time card rack, please don't hesitate to [contact us](#). Our experienced customer service representatives will be glad to answer your questions.

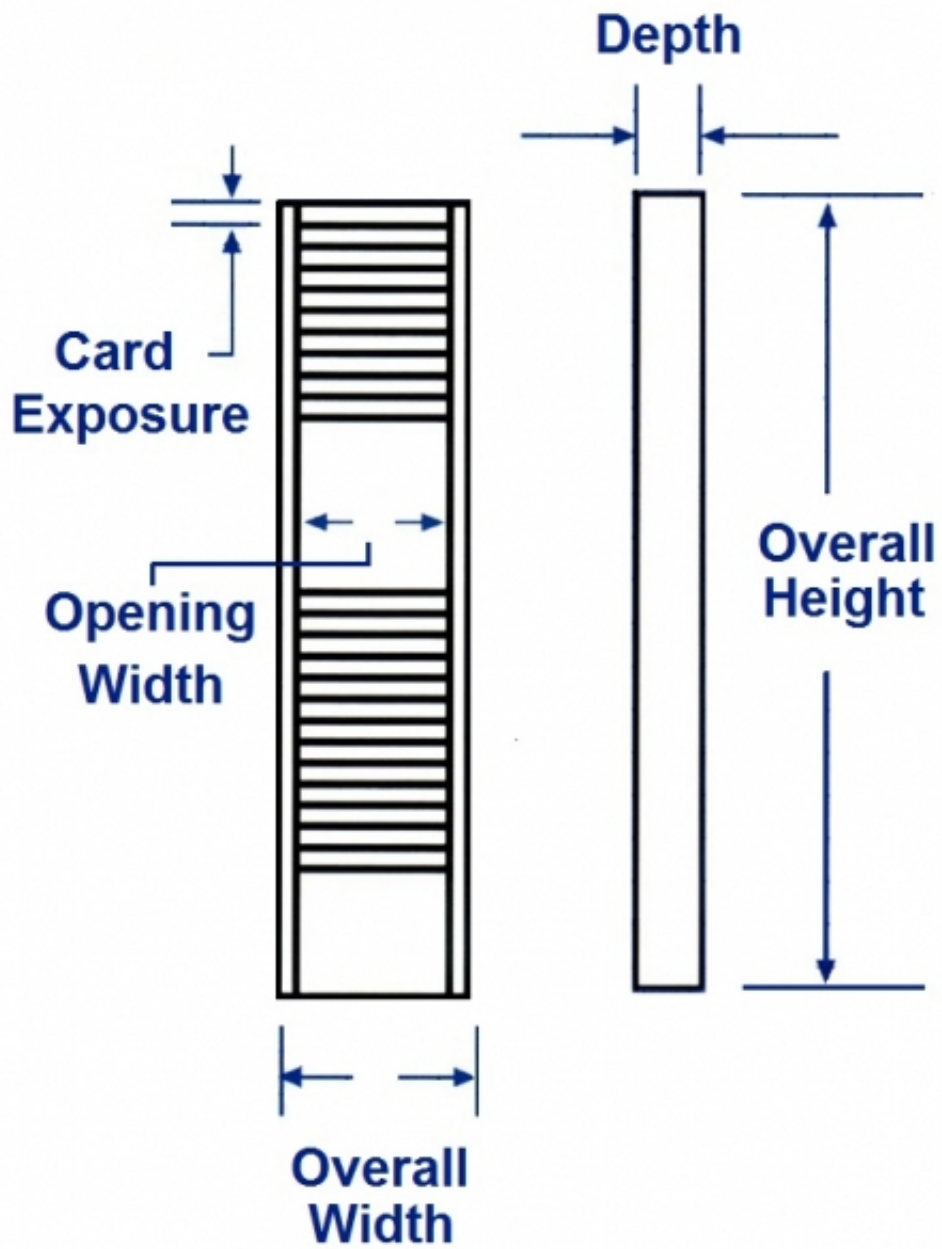

**Dimension: 31 5/8" H x 5" W x 1 3/4" D**